

Flex fire seal

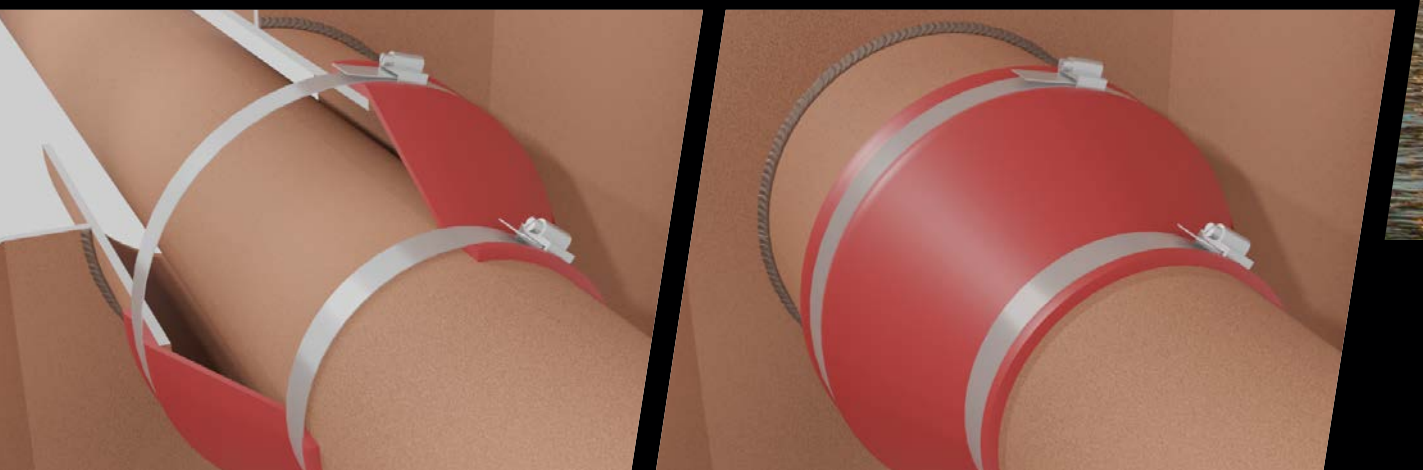

Flexible fire protection for pipe penetrations.

FLEX FIRE SEALS

Flex Fire seals meant for single or multi pipe penetrations through bulkheads and decks.

Our cutting-edge fire seals are engineered to withstand high temperatures, (Hydrcarbon/Poolfire), and prevent the spread of flames through deck and bulkhead penetrations. With Flex Fire Seals, you can create a formidable barrier, safeguarding lives and property.

The Flex Fire Seals are specifically engineered for pipe penetrations, providing targeted and effective fire protection for FPSO's, Tank Terminals, Powerplants and on- and offshore oil and gas sectors.

The seals can withstand the toughest offshore conditions and extreme temperatures. They are designed and tested for A, H and J classified bulkheads and decks.

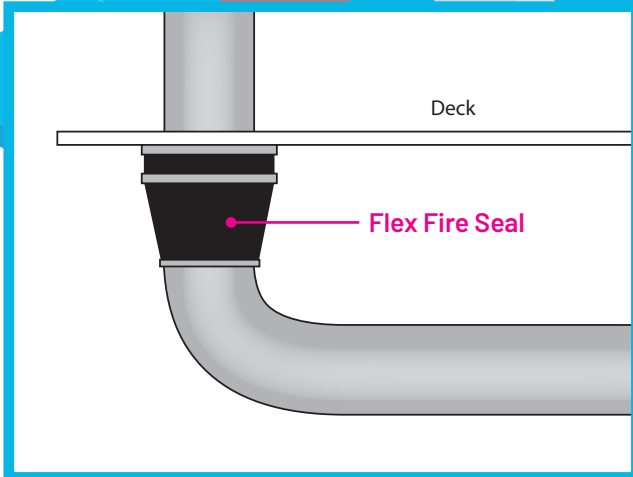
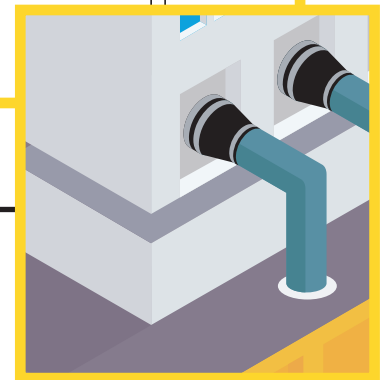
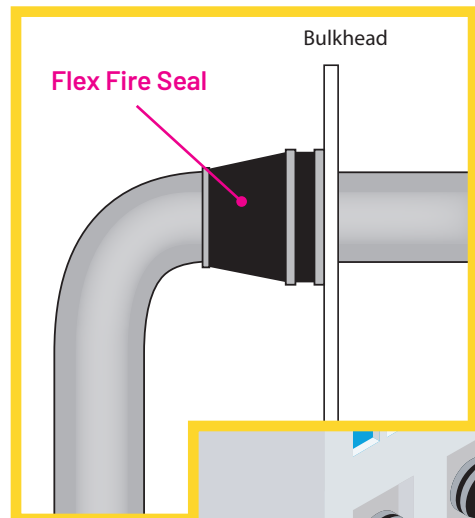
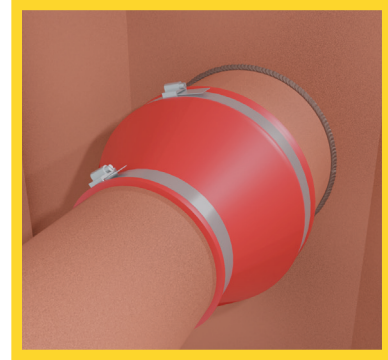

"Innovative Fire Sealing for Extreme Offshore Demands."

Our products

A0/H0-class Fire Seal

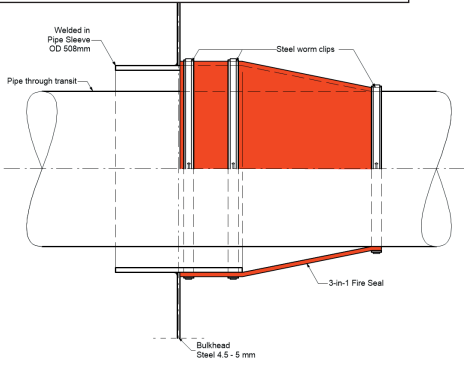

BENEFITS OF FLEX FIRE SEALS

- Easy and quick installation
- No ceramic fibers ingredients
- Suitable for single or multi pipe penetrations
- No maintenance
- No insulation required between pipe and sleeve
- Single seal can be installed on either side of the penetration
- Coated outer layer for protection against oil and chemicals
- A0, H0, J90 and J120 classified
- Endurable against harsh offshore environments

J90-J120-Class Fire Seal

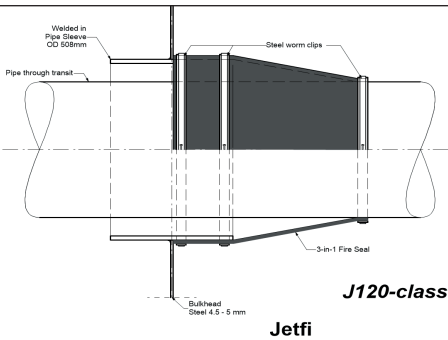

Multiple variants

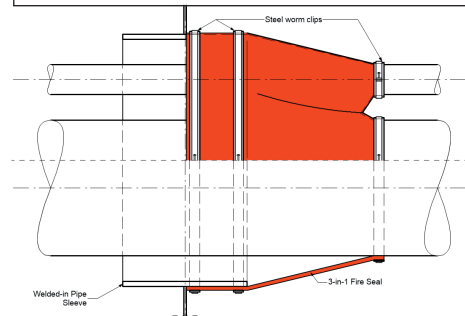

Elbow variants

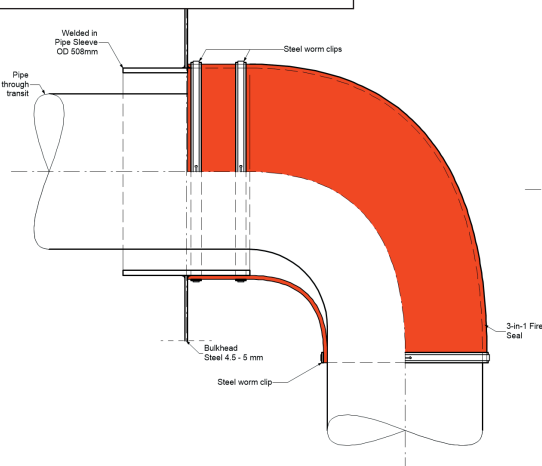

Weather Seal

